

Tesi 170cm x 70cm Idealform Plus+ Bath

ILLUSTRATED

- T0007** Tesi 170cm x 70cm Idealform Plus+ bath, no tapholes
- A6590** Tesi 2 hole dual control bath filler
- E4797** Unilux Plus+ 170cm front panel
- E4831** Unilux Plus+ 70cm end panel
- E1486** Luxury bath pop-up waste and overflow
- A5901** TMV thermostatic mixing valve, 22mm

ILLUSTRATED PRODUCT DETAILS







Weights

- T0007** 34.00 KG
- A6590** 2.33 KG
- E4797** 3.65 KG
- E4831** 2.58 KG
- A5901** 1.70 KG

Materials

- T0007** Idealform Plus+
- A6590** Chrome Plated Metal
- E4797** Acrylic
- E4831** Acrylic
- E1486** Mixed Material
- A5901** Chrome Plated Metal

Finishes

- T0007**  White (01)
- A6590**  Chrome (AA)
- E4797**  White (01)
- E4831**  White (01)
- E1486**  Chrome (AA)
- A5901**  Chrome (AA)

Capacity

- T0007** 173.0 litres (to overflow)

Designer

Artefakt Industriekultur

Standards

Constructed to EN 198:2008. EN 14516

Special Notes

Consideration should be given to safe hot water delivery and the use of an appropriate temperature reduction device, see A5901AA or Part G for guidance. One taphole fittings require offsetting from the overflow. Check positioning and compatibility before specifying.

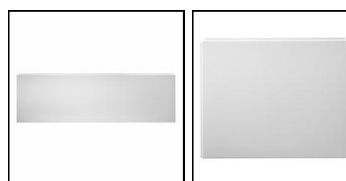
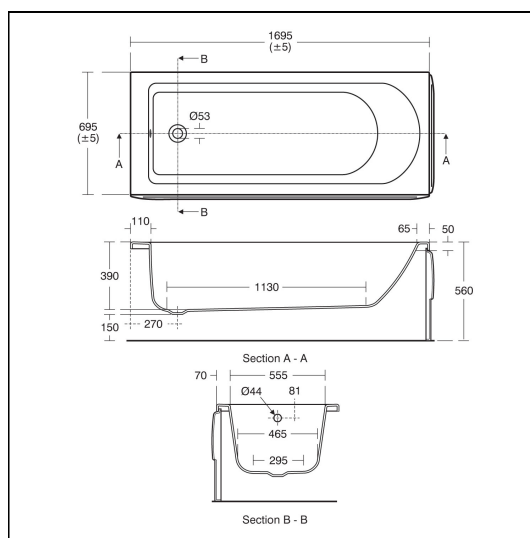

FEATURES

